

Pneumatic Grain Conveying

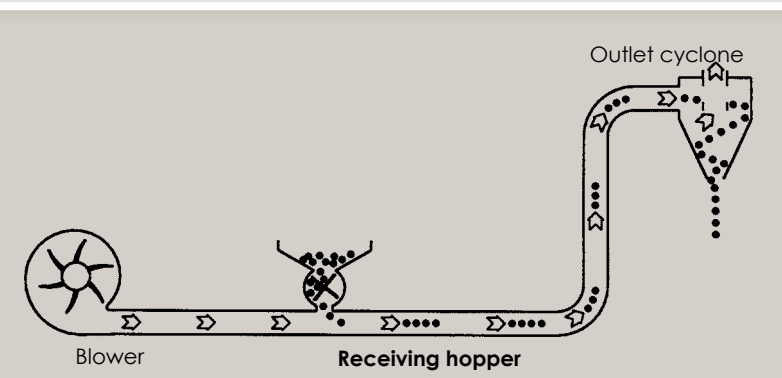

Flexible Pneumatic Conveying Solutions

High Pressure Blowers



Pressure conveying systems are used to move grain from one place to another. Pressure conveying systems require grain to be fed directly into a hopper above the injector or rotary valve.

Benefits

- Minimal space for installation, the conveying pipes can reach anywhere.
- Low weight of the conveying pipe means only small loads on buildings.
- No heavy components to be installed in inaccessible places.
- Wide range of modular pipe components and junctions means flexible installation options.
- Only electrical installation to blower and rotary intake, which are centrally located.
- Easy capacity regulation with dampers on the inlet of the rotary intake unit
- Maximum capacity is achieved with pressure conveying.

How a blower system works

When the conveying pipe is connected to the blower's pressure side a powerful air flow is directed through the conveying pipe. An injector or receiving hopper leads the material to be conveyed into the piping system. Divertors are used to convey the grain easily to different delivery locations.

How a suction system works

The blower's intake side is used for suction conveying. The blower's intake is connected to the top of a suction cyclone. A receiving hopper is fitted to the cyclone's bottom outlet. The system is suitable for suction of grain from various locations through fixed or flexible pipelines, for example directly from the floor.

Suction Blowers

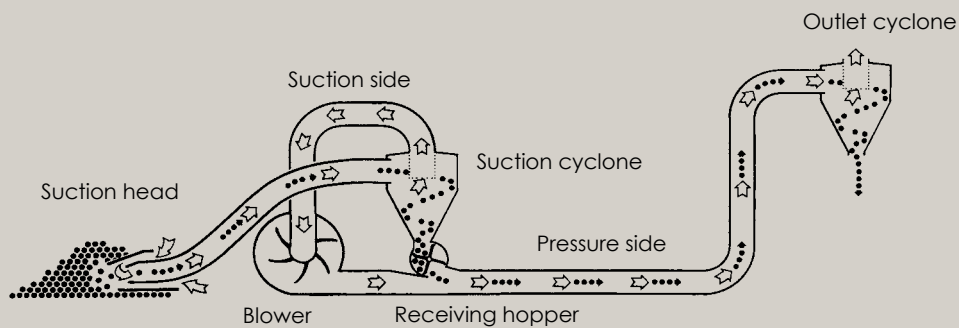

How a suction blower works

The suction blower is a unique solution when flexible conveying is needed and is used everywhere for transporting grain. It sucks grain directly from the floor or pit through a flexible or fixed pipe system.

At the blower, the grain is led over to the pipe on the pressure side.

Pipes, bends and diverters can be fitted so that the grain can be conveyed to its desired destination.

Benefits

- Tractor-powered models are independent of electric power supply
- Moves the grain horizontally, vertically and around corners
- Can be used in fields for loading grain
- No requirements for configuration of buildings or grain pit
- Indoor storage means that it is less exposed to the weather
- If higher capacity is needed, the suction blower can be replaced by a larger model

TRL High Pressure Blowers - Directly Driven



TRL 55 blower with TF 55 injector.



Directly driven rotor.



TRL 55 conveyor blower with damper for automatic adjustment of air flow.



TRL 75 blower for grain conveying and drying.

The blower creates an air flow in the pipes that conveys the grain. The amount of grain that can be blown through the pipes depends on the blower's power. Kongskilde provides blowers with different output to meet different needs.

The smaller blowers are directly driven, i.e. the blower's rotor is fitted directly to the motor shaft.

Benefits

- Moulded blower housings with soft corners provide low resistance to the air flow.
- Dynamically balanced rotors give smooth running.
- Control of the air provides efficient conveying and minimises pipe wear.
- Minimal maintenance

Technical specifications	Motor kW/hp	Power supply 50 Hz	Min. fusing recommended A	Power consumption A	Air volume max. m ³ /h	Air pressure Max mm VS/Pa	Weight kg	rpm
TRL 20	1.5/2	3 x 400V	10	3.1	1900*	250/2455	36	2850
TRL 40	3/4	3 x 400V	16	4.4	2600*	350/3440	68	2890
TRL 55	4/5.5	3 x 400V	16	7.5	1800	650/6380	77	2900
TRL 75	5.5/7.5	3 x 400V	20	10.5	3200	650/6380	92	2880

*) Injector required (Minimum back pressure from the injector necessary in order not to overload the motor.)

TRL High Pressure Blowers - Belt Driven

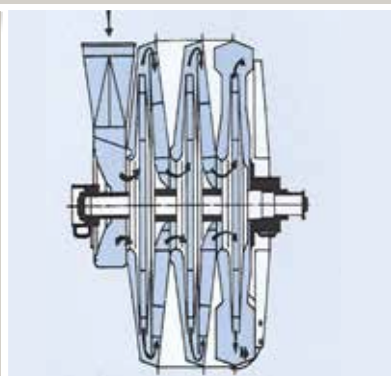

Control cabinet for TRL 150.

Automatic air control on TRL 500. Damper closes automatically during startup.

Construction of stepped high pressure blower.

V-belt drive for TRL 150.

Higher capacities require higher pressure output from the blower. The most effective way to achieve this is by increasing the rpm. For this reason, large blowers use a belt drive between the motor shaft and the blower shaft. In order to achieve sufficient pressure for larger capacities, the largest blowers have multiple rotors.

Benefits

- Effective modular system to build blowers with different outputs
- Proven design
- Air control ensures constant air flow for grain transport.
- Can be used for suction and blowing as required
- Pipe connections on both suction and pressure sides

Technical specifications	Motor kW/hp	Power supply 50 Hz	Min. fusing recommended A	Power consumption A	Air volume max. m ³ /h	Air pressure Max mm VS/Pa	Weight kg	Rev. blower /min	Rev. motor /min
TRL 100	7.5/10	3 x 400V	25	20	1800	950/9330	129	3650	2930
TRL 150	11/15	3 x 400V	35	27	1800	1300/12770	171	4200	2930
TRI 200	18.5/20	3 x 400V	35	33	1800	1700/17000	206	5800	2930
TRL 300	22/30	3 x 400V	63	39	1800	2300/22600	347	4100	2940
TRL 500	37/50	3 x 400V	100	65	1800	3500/34400	468	4300	2950
TRL 600	45/60	3 x 400V	-	78	1800	5200/51050	950	3905	2960
TRL 750	55/75	3 x 400V	-	96	1800	6400/92800	965	4310	2960
TRL 1000	75/100	3 x 400V	-	129	1800	7900/61700	1065	4780	2960

The above data refer to electrical connection 3x400V/50Hz. For other power supplies please contact Kongskilde.

Rotary Valves and Injectors

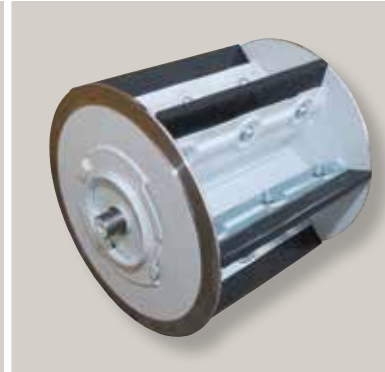

CAE 20 receiving hopper mounted below the cyclone in a pure suction installation.

TF injector with inlet hopper.

CAD 20 receiving hopper with inlet hopper and damper.

Rotor for CA 20 receiving hopper fitted with rubber slats.

A rotary valve or an injector delivers the grain into the pipeline in pressure conveying systems.

Injectors are an ideal, simple solution for small capacities.

A rotary intake unit is used for larger capacities. This is driven by a small motor that increases the capacity significantly in comparison with an injector.

Benefits

- Rubber slats provide an excellent seal against air loss.
- The rubber slats can bend to minimise clogging.
- The combination of gear and belt drive protects the intake unit against clogging.
- Belt tension is easily adjusted.
- Standard inlet hoppers and shutters to regulate inlet volumes.

CAD feeder units are used for pressure conveying, while CAE models are used for pure suction conveying.

Blower	TRL 20	TRL 40	TRL 55	TRL 75
Injector	TF 20	TF 40	TF 55	TF 55

Technical specifications	Capacity t/hour 700 kg/m ³	Motor kW/hp	Power supply 50 Hz	Power consumption A	Cell wheel/motor rpm	Weight kg	Connection top/bottom	Max pressure mm VS/Pa	Connected to control cabinet as standard
CAD 20	16	0.55/0.75	3 x 400V	1.33	65/1400	37	OK200/OK160	2000/19600	TRL150-200
CAD 30	26.5	1.5/2.0	3 x 400V	2.3	65/1400	61	OK200/OK160	4000/39200	TRL 300
CAD 40	53	1.5/2.0	3 x 400V	3.1	65/1400	97	OK250/OK160	5000/49100	TRL 500
CAE 20	16	0.55/0.75	3 x 400V	1.33	65/1400	32	OK200/(OK200)*	2000/19600	TRL 150-200
CAE 40	53	1.5/2.0	3 x 400V	3.1	65/1400	89	OK200/(OK200)*	5000/49100	TRL 500

*Optional accessory

Capacities for TRL High Pressure Blowers

Conveying capacity for purified and dried wheat (700 kg/m ³)(t/hour)	Transport Length (m)										
	10	20	30	40	50	60	80	100	120	150	200
TRL 20 + TF 20	2,3	1,9	1,6	1,3	1,1	0,9	0,7	0,5			
TRL 40 + TF 40	4,0	3,3	2,8	2,5	2,1	1,9	1,5	1,1			
TRL 55/75 + TF 55	4,3	3,7	3,1	2,7	2,4	2,1	1,6	1,3	1,1	0,8	
TRL 55/75 + CA 20	8,2	6,9	6,0	5,2	4,6	4,1	3,3	2,7	2,2	1,7	
TRL 100 + CA 20	15,3	12,9	11,1	9,7	8,5	7,5	6,0	4,9	4,0	3,0	1,9
TRL 150 + CA 20	18,5	17,9	16,2	14,1	12,3	10,9	8,7	7,1	5,8	4,3	2,7
TRL 150 + CA 30	22,3	18,8	16,2	14,1	12,3	10,9	8,7	7,1	5,8	4,3	2,7
TRL 200 + CA 20	17,5	17,4	17,3	17,3	16,3	14,6	11,8	9,8	7,8	6,4	4,3
TRL 200 + CA 30	27,9	23,8	20,6	18,1	16,0	14,3	11,7	9,7	7,8	6,3	4,3
TRL 300 + CA 30	29,7	28,7	27,0	23,8	21,2	19,0	15,7	13,2	11,2	9,0	6,5
TRL 300 + CA 40	36,1	31,0	27,0	23,8	21,2	19,0	15,7	13,2	11,2	9,0	6,5
TRL 500 + CA 40	49,5	44,0	39,5	35,8	32,6	30,0	25,6	22,3	19,6	16,5	12,7
TRL 600 + CAD 50	59,3	52,7	47,4	42,9	39,2	36,0	30,7	26,7	23,6	19,7	15,2
TRL 750 + CAD 50	74,0	65,8	59,2	53,6	48,9	44,9	38,3	33,3	29,4	24,6	19,0
TRL 1000 + CAD 50	91,6	81,4	73,2	66,3	60,5	55,5	47,3	41,2	36,4	30,4	23,5

The table is based on a 4 m vertical lift and two 90° bends in the pipeline. The rest of the pipe is horizontal.

Various factors affecting the conveying capacity:

- Crop water content, based on 15% for cereals.
- Extra lift height reduces capacity.
- Multiple bends reduces capacity.
- Air temperature and barometric pressure
- Purity of the grain



Blower graph

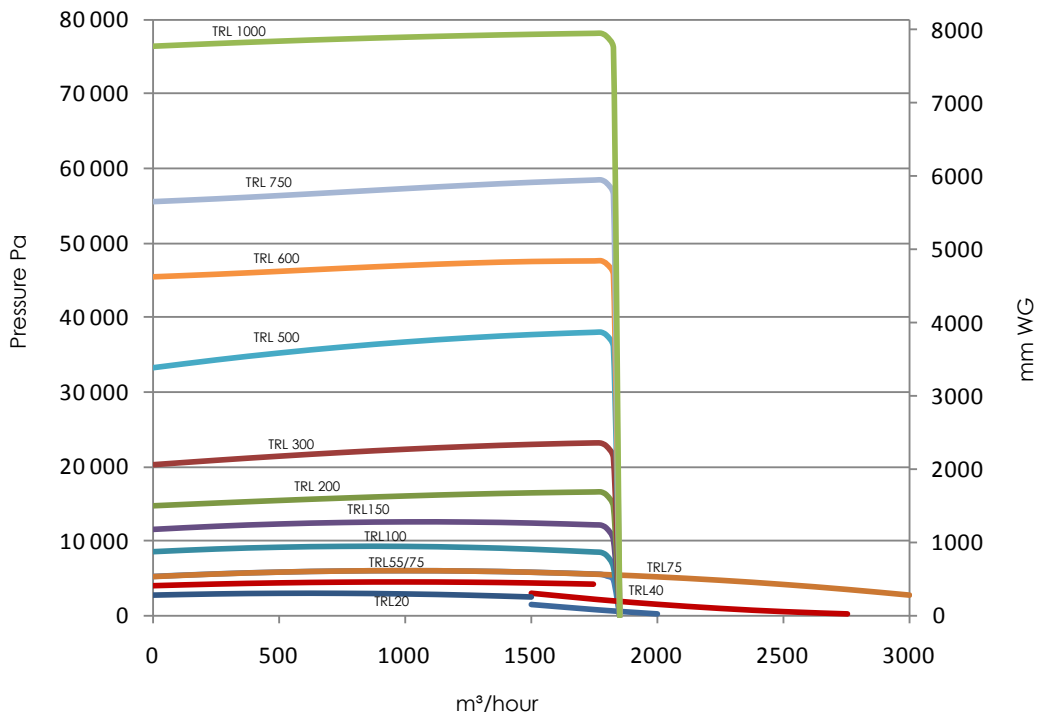

Electric-Powered Suction Blowers

Type SUC -E



Type SUC-E is trolley mounted and easy to move.



Control cabinet for automatic starting/stopping the motor.



SUC 300E with automatic air regulation.



Belt transmission protects drive of both blower and cell wheel.

Kongskilde's wide range of suction blowers can be supplied for either electric or tractor power.

Permanently installed conveying systems are usually based on electrically powered devices.

El-powered suction blower SUC -E:

- For grain transport in barns
- Capacities up to 33 t/h
- On wheels and easy to move

Technical specifications	SUC 100 E	SUC 150 E	SUC 200 E	SUC 300 E	SUC 500 E
Motor power (blower), kW/hp	7.5/10	11/15	15/20	22/30	37/50
Motor power (receiving hopper), kW/hp	0.37/0.5	0.37/0.5	0.37/0.5	1.1/1.5	1.5/2.0
Electrical connection, V/hz	3x400/50	3x400/50	3x400/50	3x400/50	3x400/50
Total amps consumption	16	22	30	44	73
Min. amp. fusing (recommended)	25	35	50	63	100
Weight incl. motors, kg	210	243	285	477	668
Max. air output, m ³ /h	1800	1800	1800	1800	2000
Type of conveying pipe	OK/OKR	OK/OKR	OK/OKR	OK/OKR	OK/OKR
Diameter of the conveying pipe, mm	160	160	160	160	160
Control cabinet with automatic star/delta starter*	Yes	Yes	Yes	Yes	Yes

* Only motorised blowers

The above data refer to electrical connection 3x400V/50Hz. For other power supplies please contact Kongskilde.

Tractor Powered Suction Blowers Type SUC –T



Three-point attachment to tractor lift.



SUC 500T compact construction.



Three-stage blower on SUC 500T provides high pressure for grain conveying.



Automatic air control is standard on tractor-powered blowers.

Tractor-powered suction blowers type SUC-T is attached to the tractor's three-point linkage. Capacities up to 44 t/h. Also available without suction equipment for pure compressed air conveying. Provides approx. 20% increased capacity.

Technical specifications	SUC 300 T	SUC 500 T
Recommended min. power of tractor PTO kW/hp	34/45	48/65
PTO shaft speed, rpm	540	540
PTO shaft dimension, tractor side	1 3/8" / 6 splines	1 3/8" / 6 splines
Weight, kg	350	595
Blower max. air output, m ³ /h	1800	2000
Type of conveying pipe	OK/OKR	OK/OKR
Diameter of the conveying pipe, mm	160	160

Tractor Powered Suction Blowers Type SUC-TR



The blower's loading equipment ready for road transport.



The TR models loading equipment is ideal for loading lorries and trucks.



Powerful blower with up to 4 steps provides great conveying out-put.



The belts can be tightened without using tools, although tools are required to gain access to the belts.

Trailer models type SUC-TR are powered by the tractor PTO shaft.

Loading equipment is standard on SUC-TR models. You use the loading equipment when you are loading grain onto a truck or lorry.

Technical specifications	SUC 500 TR		SUC 700 TR	SUC 1000 TR
Recommended min. power of tractor PTO kW/hp	48/65	48/65	62/85	90/120
PTO shaft speed, rpm	540	1000	1000	1000
PTO shaft dimension, tractor side	1 3/8" 6 splines	1 3/8" 21 splines	1 3/8" 21 splines	1 3/8" 21 splines
Weight, kg	820	730	770	1050
Blower max. air output, m ³ /h	1800	1800	1800	1800
Type of conveying pipe	OK/OKR	OK/OKR	OK/OKR	OK/OKR
Diameter of the conveying pipe, mm	160	160	160	160

Tractor Powered Suction Blowers Type SupraVac 2000



Loading equipment on SupraVac 2000 ready for loading grain onto lorry.



Loading equipment hydraulically folded for the transport position.



Connection of pipe system. E.g. mounted on silos for filling.



Transport box (extra) for the suction head and pipe components.

SupraVac 2000 is the latest addition to our tractor-powered suction blowers. With a capacity of up to 120 tonnes/hour, you load even the largest vehicles quickly.

Technical specifications	SupraVac 2000
Recommended min. power of tractor PTO kW/hp	125/170
PTO shaft speed, rpm	1000
PTO shaft dimension, tractor side	1 3/8" 21 splines
Weight, kg	1600
Blower max. air output, m ³ /h	3300
Type conveying pipe (suction side)	OKR
Type conveying pipe (pressure side)	OK/OKR
Diameter of the conveying pipe, mm	200
Hydraulic connection	200, 1/2" ISO 0228
Hydraulic pressure, min.	50 bar

Selecting the Suction Head for the Suction Blower



The suction head makes the difference

The suction blower can be used with different types of suction heads to suit any specific conveying job.



Universal Suction head:

A flexible solution for versatile applications.



Long suction head:

Suitable for conveying from grain pits.



Round suction head:

For suction from opening in the silo wall.



Suction head for cleaning purposes:

Easily picks up the last remnants of grain on the floor.



Short suction head:

For conveying directly from a vehicle or floor drying wall

Conveying of Crops with High Dust Content



Crops sometimes contain abrasive particles such as soil dust, and it is inevitable that some of the dust will be sucked through the blower. When working at high capacities, large amounts of dust may be carried with the grain.

Excessive wear of the blower is avoided by fitting the Fan Guard system, which filters out the dust before it enters the blower. SUC 1000 TR and SupraVac 2000 are available with the Fan Guard system.

Conveying Capacities for Suction Blowers

Example 1

Suction pipeline

- 1 x universal suction head
- 1 x 2 m steel flex hose

Pressure pipeline

- A number of metres of horizontal piping
- 4 m vertical piping
- 2 x 90° bends
- 1 x outlet cyclone

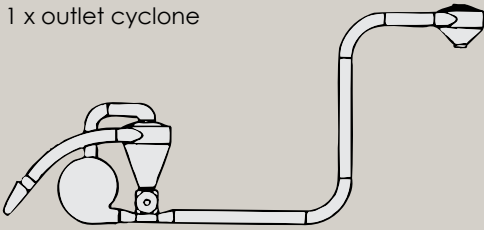

Conveying distance		Metres							
Model	10	20	30	40	50	60	80	100	
SUC 100	6.8	6.0	5.2	4.6	4.0	3.5	2.7	2.0	
SUC 150	11.5	10.3	9.3	8.4	7.6	6.9	5.7	4.8	
SUC 200	14.7	13.3	12.0	11.0	10.0	9.2	7.8	6.7	
SUC 300	19.6	17.7	16.0	14.6	13.3	12.3	10.5	9.0	
SUC 500	31.8	28.9	26.5	24.4	22.6	21.0	18.3	16.1	
SUC 700	42.1	38.6	35.5	32.9	30.6	28.6	25.1	22.4	
SUC 1000*	61.0	56.0	51.5	47.7	44.4	41.5	36.4	32.5	
SupraVac 2000	111.0	91.0	82.0	71.0	64.0	59.0	52.0	43.0	

Example 2

Suction pipeline

- 1 x vertically-fixed universal suction head
- 1 x 90° bends
- 1 x 2 m horizontal piping

Pressure pipeline

- A number of metres of horizontal piping
- 4 m vertical piping
- 2 x 90° bends
- 1 x outlet cyclone

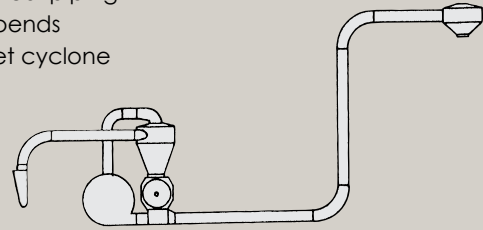

Conveying distance		Metres							
Model	10	20	30	40	50	60	80	100	
SUC 100	7.1	6.2	5.4	4.7	4.1	3.6	2.7	2.0	
SUC 150	12.1	10.7	9.6	8.6	7.8	7.0	5.8	4.8	
SUC 200	15.7	13.9	12.5	11.2	10.1	9.1	7.5	6.2	
SUC 300	20.4	18.2	16.4	14.9	13.6	12.5	10.6	9.1	
SUC 500	33.2	30.1	27.4	25.1	23.1	21.4	18.6	16.3	
SUC 700	44.2	40.3	36.9	34.0	31.5	29.3	25.6	22.7	
SUC 1000*	64.0	58.4	53.5	49.3	45.7	42.5	37.1	32.9	
SupraVac 2000	120.0	106.0	92.0	81.0	71.0	64.0	55.0	50.0	

Conveying capacities in the tables are listed as wheat as t/hour. The examples are for guidance purposes, as several factors influence the capacity. The capacities in the tables apply for the suction length indicated above the table.

*) Spec. round suction head.

Use the wide range of OK piping components, that are available and take advantage of the pipe components' easy connection method.

Capacities

High performance is achieved when:

- The flexible modular OK piping system is used.
- The correct pipe diameter is used.
- The grain is dry – i.e. max. 15% H₂O.
- OK 200 piping for SupraVac
- OK 160 piping for all other models

Kongskilde OK Pipe Systems



Screw coupling and quick coupling for assembly of pipe components.



Assembly of pipes with quick coupling.



Wide range of pipe components for simple construction of pipe systems.



Pipe assembly for filling outdoor steel silos.

OK pipe systems

Access to an efficient pipe system is essential for the provision of high-performance pneumatic conveying systems. Kongskilde's OK 160 and OK 200 pipe ranges are built to meet the requirements of pneumatic conveying systems.

Benefits

- OK 160 and OK 200 are standard piping systems.
- OKR 160 and OKR 200 are reinforced piping systems with greater material thickness.
- OKX 160 bends have hardened wear surfaces to provide high durability and long life.
- Quick couplings for pipelines, when frequent repositioning is needed.
- Screw couplings for permanent pipeline installation.

Kongskilde Industries A/S



When this year's harvest is in house, it is essential that the crop is handled and stored carefully to preserve its agricultural value. The Kongskilde grain product programme offers farmers equipment that lives up to this and suits both small and large farms.

The Kongskilde grain product programme includes:

- Pneumatic transport
- Mechanical transport
- Cleaning and weighing
- Drying
- Storage
- Complete system solutions
- Measurement equipment and accessories
- Heat sources - oil and gas heaters and electric heaters
- Straw Drying

The solutions are based on pneumatic or mechanical transport, storage in floor stores or steel silos, tunnel or circulation dryers and many other details.

When cold and damp are damaging crops and creating unnecessary costs, Kongskilde mobile heaters can provide heat to overcome the problem easier and cheaper than you would think.

Sensor spheres placed in cereal and seed stores monitor the crops around the clock so the high heat does not damage them, while at the same time achieving efficient drying, traceability, quality assurance, self-monitoring and stock inventory of the crops.

Kongskilde is a company with strong traditions, as well as innovative brands, and is today known for its development of products that contribute to the efficiency of modern agriculture. Kongskilde is known for its special expertise in installations

for conveying, drying, storage and cleaning of grain and other crops, and for drying of big bales. In addition, Kongskilde offers a comprehensive range of mobile heat sources for drying tasks and heating in agriculture, construction and industry.

Kongskilde was established in 1949, when mechanisation of agriculture began to be felt in Denmark. The company's first products were cereal blowers, tine harrows and mobile heaters. These products, which at the time set new standards, still form the basis of much of Kongskilde's business in agricultural implements and grain handling equipment.

Today, Kongskilde has become a "full-line" business in tillage, grass machinery, diet mixers and grain handling facilities. The company is represented with subsidiaries in 13 countries and with manufacturing facilities in five countries.